

Varenummer: 01010211  
 Beskrivelse: Seeger låsering A 8 DIN 471  
 Rustfast 411  
 Note: Monteres med ZGA tang

## Mål

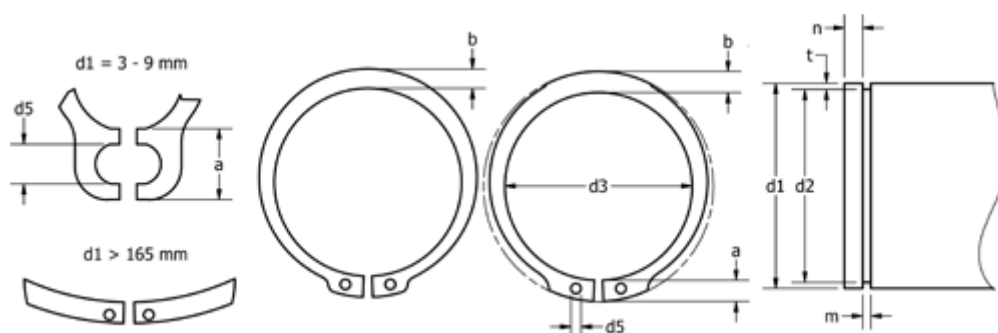

a max	= 3,2	FN kN	= 0.8	s	= 0.80
AN mm <sup>2</sup>	= 4.9	FRg kN	= 2.00	t	= 0.20
b	= 1.5	FR kN	= 3.00	Tang	= ZGA-0
Betegnelse	= A8	g	= 0.5	tol	= -0.05
d1	= 8	K kN-mm	= 14.20	tol	= +0,06-0,18
d2	= 7.6	m min	= 0.90	tol	= -0.06
d3	= 7.4	n abl x 1000	= 96.0	vægt kg/1000	= 0.158
d5 min	= 1.2	Nominel træk	= 0.6		